

TLE Series™ UPS

160-800 kVA/kW three phase 400 Vac
with best-in-class efficiency





GE provides clean, efficient and reliable power for today's digital world with the ultra high efficiency TLE Series UPS.

GE's TLE Series Uninterruptible Power Supplies 160-800 kVA/kW

The TLE Series UPS is one of the best performing three-phase UPS systems providing critical power protection for a wide range of applications. The TLE Series operates in VFI mode (Voltage Frequency Independent) and has been developed to satisfy the growing request of high efficiency through an innovative control algorithm with 3-level inverter technology. This innovative product provides best-in-class efficiency in double conversion mode as well as eBoost™ operating mode. The TLE Series is developed using GE's Design for Six Sigma methodology to help ensure that the product fully meets customer requirements and expectations.

The TLE Series UPS provides industry-leading reliability, efficiency, clean input performance and unity power factor at output. Reliability can be further increased by paralleling more units utilizing GE's unique RPA™ (Redundant Parallel Architecture) technology. Through their complete life cycle, all GE UPS systems are fully supported by service teams which provide world-class, 24x7 preventive and corrective services, training and application expertise.

Ensuring uptime for critical processes

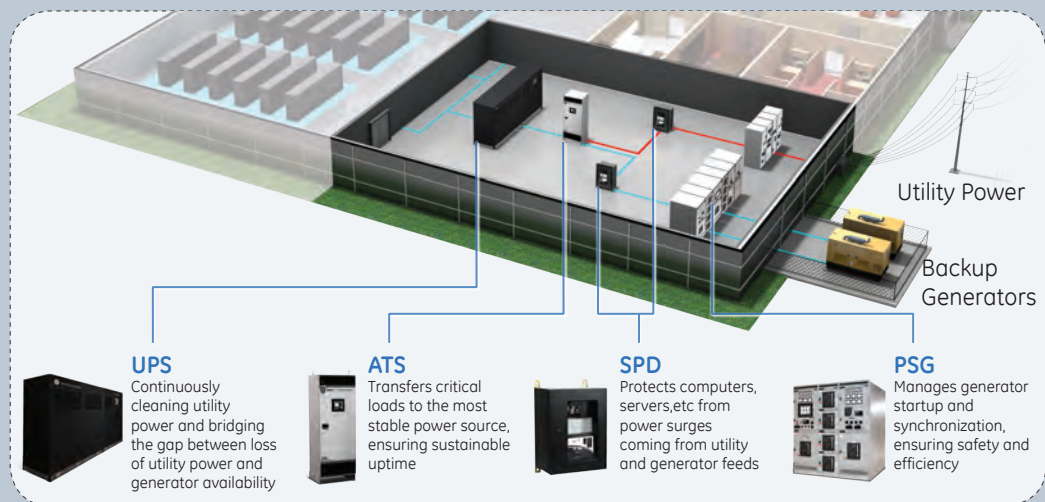

For mission critical processes, customers rely on our industry-leading power quality solutions to increase critical system reliability. GE's Critical Power business has technology that delivers superior performance and industry-leading energy efficiency for facility backup power management. In addition to our UPS Solutions, we provide the Standby Generator Paralleling Switchgear, Automatic Transfer Switches and Surge Suppression Devices that deliver power efficiently and reliably.

TLE Series UPS 160-800 kVA/kW

Delivering Best-in-Class Efficiency with Innovative Technology

GE's TLE Series UPS is one of the most efficient and reliable three-phase UPS systems, providing best-in-class efficiency, output performance and critical power protection for your data center needs. The TLE Series UPS solutions are optimized to provide high efficiency at part load conditions.

The TLE Series UPS helps assure low input current harmonic distortion, best-in-class output voltage regulation and dynamic response. This helps customers save operational costs while implementing environmentally-friendly solutions.

Efficiency and Technology Provide Low Total Cost of Ownership

- High efficiency in double conversion mode up to 96.5% and eBoost mode operation up to 99%.
- High double conversion efficiency provides substantial life cycle cost saving in power and cooling cost of up to \$ 2 MM for a 6 MW data center
- Clean input performance keeps the supply network clean and provides advantages by reducing size of circuit breaker, cables and generator.

Easier Installation and Configuration Flexibility

- True front access for operation and maintenance reduces mean time to repair (MTTR)
- Standard built in back feed protection and maintenance switch minimize installation cost and increase safety
- Smaller size reduced installation and operational foot print
- Redundant Parallel Architecture (RPA) for reliability, redundancy and scalability up to 6 UPS

High Performance and Availability

- Enhanced output performance with unit power factor to protect and supply modern IT load
- Excellent dynamic performance and low output voltage distortion
- Improved diagnostic capabilities with waveform capture and capacitor monitoring



Key Features

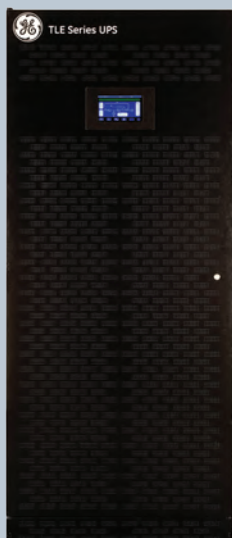

Clean input performance with 0.99 input power factor and <3% THDi

Double conversion efficiency up to 96.5%

Output power factor 1

True front access design

Compact foot print

Improved user interface

Extremely low output voltage distortion

Superior Battery Management

Energy Efficiency is our focus

GE's TLE Series UPS is one of the most energy efficient double-conversion UPS in the industry, and provides world-class energy efficiency across the operating load range. The TLE Series delivers efficiency up to 96.5% in double conversion mode and 99% in eBoost operating mode. This system efficiency substantially reduces operating and cooling costs thus providing a reduced cost of ownership and improved power usage effectiveness (PUE) compared to conventional UPS.

GE's UPS performance is optimized at 50-75% load operation, as this is the most common operating range. The optimization of the TLE Series includes selecting all major power chain components based on maximizing the component efficiency at part load conditions.

High Efficiency TLE Series UPS Provides:

- Substantial reduction in operating cost of UPS
- Reduced energy loss minimizes air conditioning requirement
- Energy savings from reduced cooling

TLE 200 kW UPS EFFICIENCY

TLE series delivers efficiency up to 96.5% in double conversion (VFI) mode and 99% in eBoost operating mode

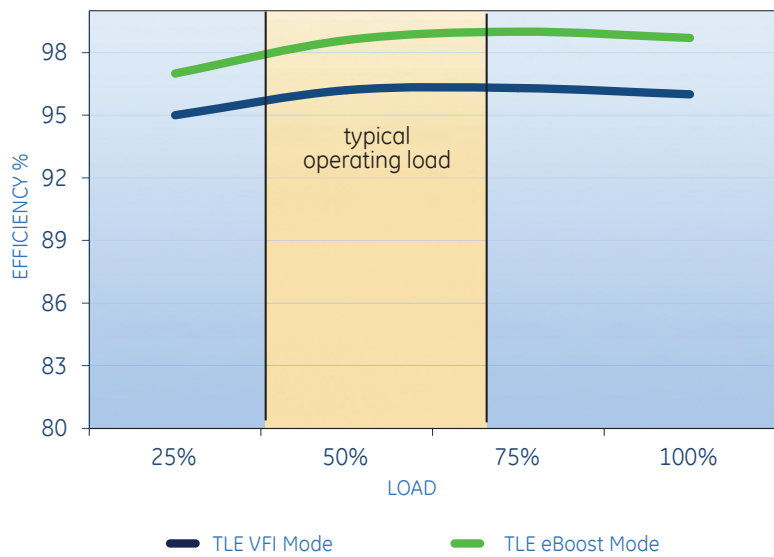

eBoost

Energy consumption is a critical issue for IT organizations as their datacenter energy demands continue to grow. Their goal is to reduce cost and keep the datacenter running. IT organizations can reduce energy consumption costs without sacrificing system reliability with GE's eBoost technology.

e = high efficiency up to 99%

Boost = fast transfer to inverter < 2ms

TLE Double Conversion (VFI) - 3 Level Converters

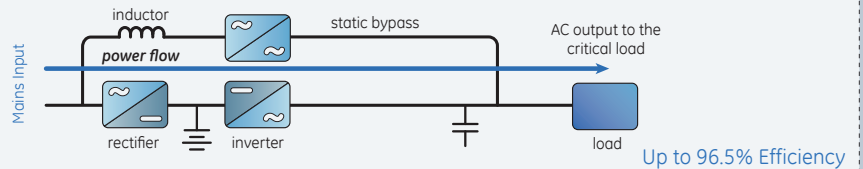

TLE eBoost (VFD)

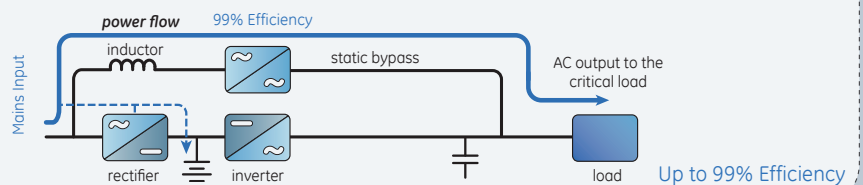

High Efficiency – Data Center Life Cycle Cost Savings

The TLE Series with 96.5% efficiency in double conversion mode and 99% efficiency in eBoost operating mode provides considerable life cycle cost savings in comparison to a traditional transformer less UPS operating at 94% efficiency. Savings are dependent upon load, power cost and life cycle duration (years).

For 6 MW load TLE series provides savings of \$2 MM while operating in VFI mode.

Assumptions:

- Power cost = \$ 0.10 /kw-hr
- Operating hours/year = 8760
- Configuration = S+S operating at 50% load

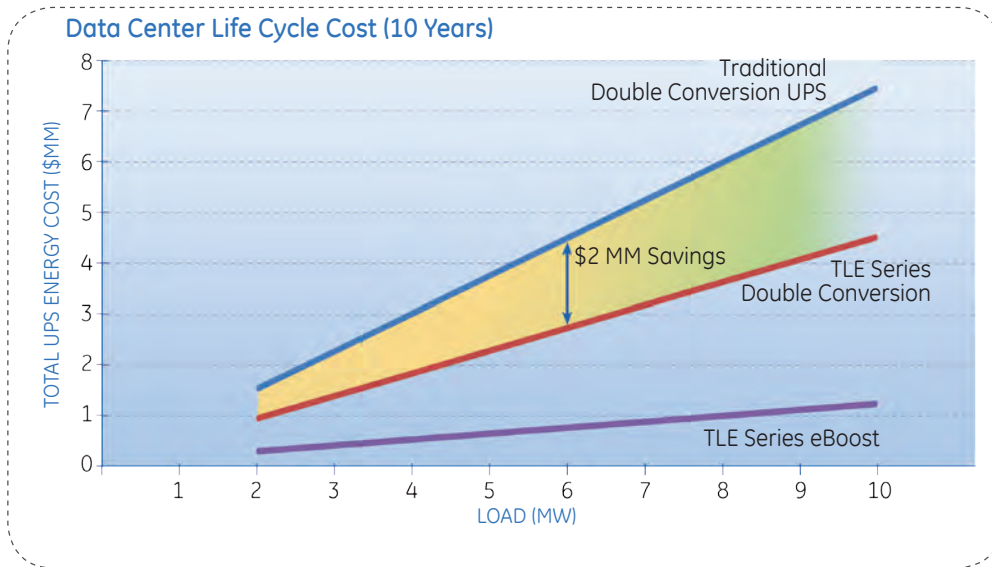

eBoost Performance

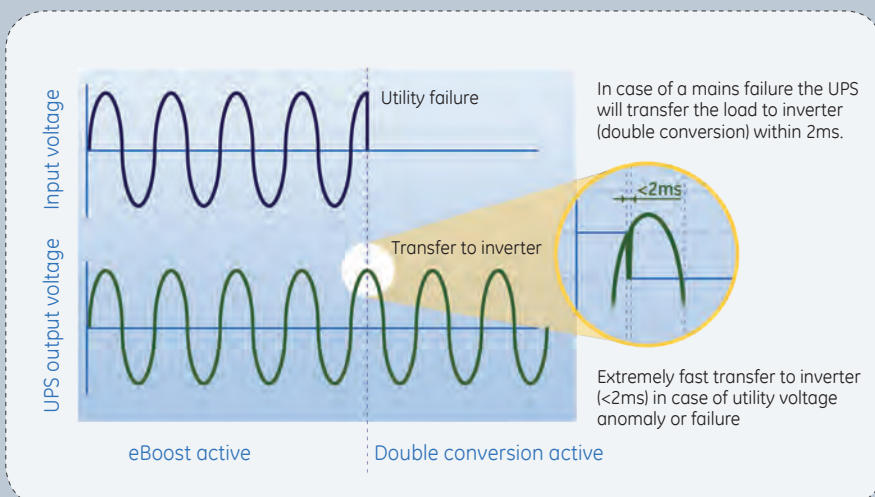

Specifications

On TLE Series products, 160-800 kW single module and Redundant Parallel Architecture (RPA) operation:

- Fast transfer to inverter: <2ms
- Input voltage range: +/- 10%
- Input frequency range: +/- 3%
- Efficiency: up to 99%

Innovative Product Technology

3 Level Technology for High Efficiency

The TLE Series UPS uses a three level technology with an Advanced Neutral Point Clamped topology implemented with true Reverse Blocking IGBT. These result in reduced switching and filter losses with respect to a standard two level technology. Combined with optimized magnetics, the net result is an ultimate 96.5% efficiency in double conversion mode. In addition, the high level of integration and the optimized power layout result in clean commutations with no over-voltages which in turn translate into reduced component stress and increased reliability.

Superior Battery Management (SBM)

Every GE UPS incorporates a standard feature called Superior Battery Management (SBM) that can be configured to periodically test the battery system and calculate true battery runtime using measured values for temperature and load.

Advantages

- Works with all battery types: Flooded, VRLA, NiCD
- Programmable features allow the user to select the frequency and type of battery tests that are performed:
 - Frequency range can be from once per week to once annually
 - Test type range can be from deep cycle to 3-min discharges
 - Manual tests can be performed at any time
- Temperature compensated battery charger - prevents overcharging
- Programmable end of discharge voltage - protects against deep discharge
- Deep discharge test (manually) - provides battery performance tracking
- Boost charging - enables fast recharging of batteries

Improved Diagnostic and Reliability with New DSP Control

Every TLE Series UPS incorporates improved diagnostic capabilities with the new FLEX DSP control board that provides capability of waveform capture, diagnostic and trend analysis. The TLE Series is also equipped with special hardware and monitoring capability for limited life components like fans and capacitors.

- Waveform capturing capability
- Fan failure detection
- Component life time counters (fan and capacitors)
- AC capacitor health monitoring
- IGBT status diagnostic

Improved reliability and availability

- Dedicated supply for bypass logic
- Dedicated supply for connectivity channels
- Redundant logic for emergency bypass activation
- Main-board integrated RPA control: RPA board contains only interface hardware
- More robust RPA communication (Manchester coded) CRC - cyclic redundancy check

Improved Diagnostic Capability

- Waveform capture, diagnostic and trend analysis
- Diagnostic details accessible to service personnel
- Simultaneous acquisition of 32 channels
- Sampling frequency up to 10kHz
- Smart trigger capability with up to 16 independent trigger sources to record only specific events with pre/post trigger data acquisition
- 8 buffers to record up to 8 events without losing older events

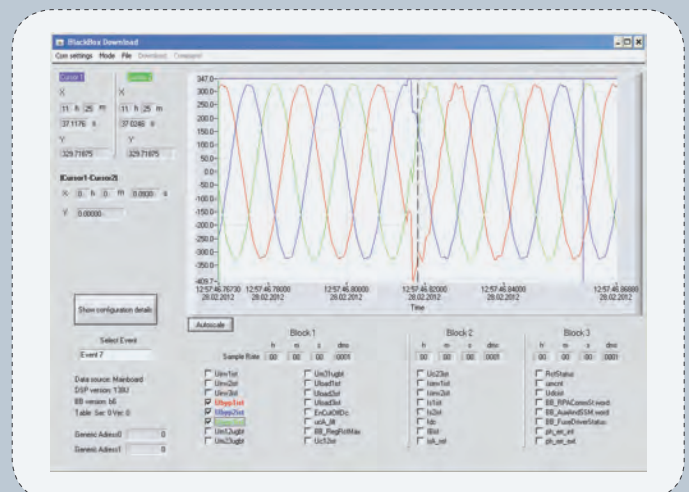



Input Performance

Clean Input Performance

The TLE Series IGBT based rectifier and innovative control algorithm ensures an input Total Harmonic Distortion (THDi) of less than 3% and draws a pure sinusoidal waveform from the mains. This also provides UPS input power factor of 0.99.

Advantages

- Saving in the sizing of upfront equipment e.g. emergency generators, cabling, and circuit breakers
- No disturbances to nearby equipment; eliminate perturbation and outage on upfront electrical equipment, avoiding also any investigation and analysis cost due to malfunction

Programmable Soft Start

The programmable soft start allows the rectifier to ramp up in a programmable time period (0-15 seconds) thus eliminating in-rush current. This feature reduces the need of oversizing the input power system (gensets, feeder cables, and overcurrent devices).

Generator Compatibility

User-programmable features such as slew rate, phase angle rate-of-change and voltage rate-of-change allow the UPS to quickly sync to a genset during emergency back-up.

Output Performance

Total Harmonic Distortion (THD)

A distorted output voltage waveform affects the proper function of the load's equipment. The TLE Series has very low output voltage THD, even with connected 100% unbalanced or 100% non-linear loads.

Output Power Factor 1

- TLE Series with unity output power factor provides more output power. Output power factor diagram symmetrical with respect to zero. 100% kVA – no derating with any load.
- Suitable for modern power supply application with unit or capacitive power factor (e.g. new servers generation), crest factor up to 3:1.

Transient Response

Transient response is very fast due to control algorithms which ensure very high dynamic stiffness. This reduces the need to oversize the UPS for pulse load applications.

TLE Series Power Capability

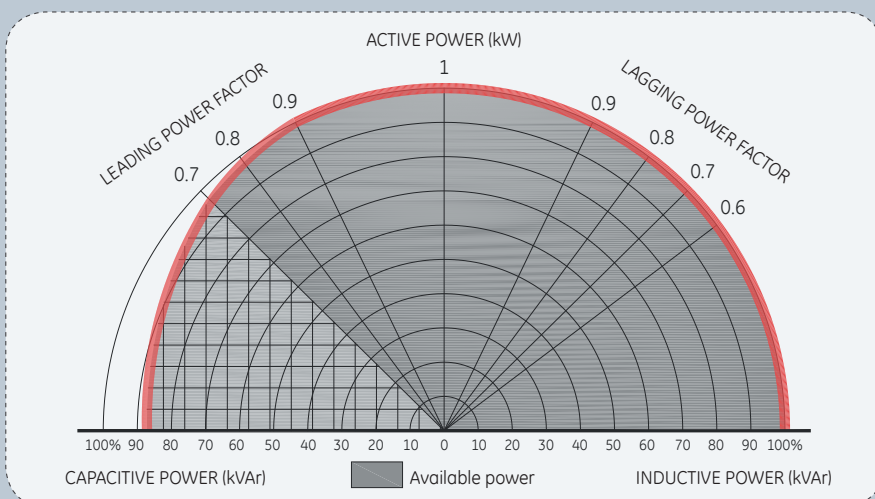

Unity output power factor, full power for critical load without derating for actual and future IT loads.

Advanced User Interface

The TLE Series UPS is equipped with menu-driven touch screen display panel provides easy to read details on UPS status and metering, parameter settings, UPS configuration. This user-friendly display panel provides:

- Critical measurement of input, output and battery included with mimic diagram
- Quick operational status
- Measurement and operational status of RPA system
- Different access level for user and service
- Multilanguage communication interface supporting: English, German, Italian, Spanish, French, Finnish, Polish, Portuguese, Czech, Slovakian, Chinese, Swedish, Russian and Dutch.

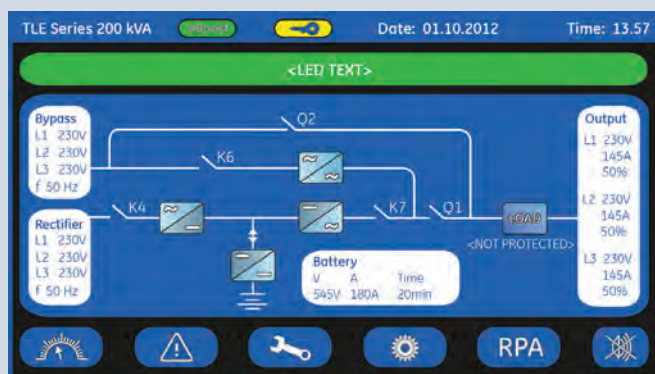

TLE Series Ease of Installation & Improved Serviceability

Front Access

TLE Series is designed to have front access for all the critical components that reduces mean time to repair (MTTR).

Modular & Draw Out Construction

All the sub-assemblies for the TLE Series are designed and assembled to have slide out modular construction that allows fast maintenance and service.

Improved Diagnostic

TLE Series new diagnostic features allows to store different wave forms and also provides fan failure detection as well as warning on capacitor life that improves UPS availability and enhances preventive maintenance capabilities.

Standard Safety and Maintenance Feature

TLE Series UPS has standard built in back-feed protection as well maintenance switch (standard for TLE 160-400 kW) that avoids external installation of switches or breakers into input distribution panels for providing back feed protection and maintenance disconnect.

Power Quality Service

Performance Through People

Whether you are a large corporation with multiple sites or a small business owner with a single location, GE will enable you to have a constant supply of clean and reliable power to keep your business up and running.

GE has local offices in a number of countries around the globe and also a network of selected business partners, whose salespeople and service engineers combine expertise in our solutions with an in-depth knowledge of local market conditions.

GE's service & authorized service providers business partners, located in more than 100 countries around the world, use all that expertise and knowledge to adapt GE's products and services precisely to their customers' needs.

- On site & emergency services
- Service agreements
- Spare parts and repairs
- Support and remote services
- Online support



Redundant Parallel Architecture™ (RPA) System Configuration

GE provides RPA, a unique technology that can parallel UPS modules with true redundancy by eliminating any single point of failure. RPA provides a scalable paralleling technique that reduces operating footprint and increases system reliability by eliminating the need for external paralleling equipment and cabinets (centralized bypass and master control).

One of the UPS modules in the system intelligently takes the leadership role, while the other UPS modules have access to all control parameters. If one UPS fails to operate, the load is automatically redistributed among the others. If the lead UPS fails to operate, then another UPS automatically takes on the leadership role. GE's RPA technology is implemented by distributing the control electronics within each UPS module in the system.

RPA™ System Advantages

No Single Points of Failure

The RPA system provides complete redundancy of all critical components, allows paralleling of up to 6 units for increased load capacity or redundancy.

Bypass Inductor Design

Ensures excellent output voltage regulation between paralleled modules and assists bypass line conditioning (eBoost only).

Scalable and Modular

The system can be easily expanded for higher capacity and redundancy without any interruption to the critical load or transfer to bypass.

Redundant Communication

Redundant high speed bus and control electronics provide higher system reliability.

Distributed Control Logic

Each module in an RPA system has its own operational controller. Each one continuously communicates with all others in order to manage the entire system like a team.

Online Maintenance

N+1 configurations allow maintenance on any single module in the system while other modules provide online protection with battery backup.

Sequential Soft Start

Provides sequential soft start of each module to reduce instantaneous load on input feeders during mains recovery. This helps avoid over-rating of generator and overheating of cable and fuses.

RPA Cable Saver

UPS Module input and output cable length variation up to 10% between modules. With eBoost technology this cable length flexibility is increased between modules.

Smaller Footprint

RPA eliminates centralized control and external static bypass cabinet.

GE's RPA™ System

Standard RPA™ Configuration:

True Redundancy with Distributed Control & Bypass

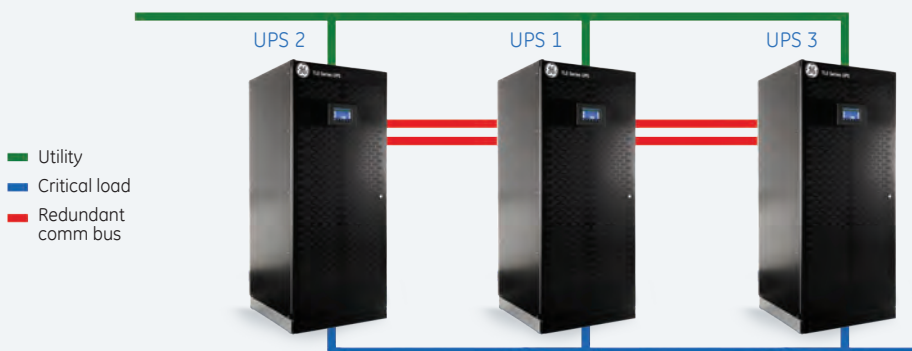

Configurable up to 6 units in parallel

- Future expansion
- Safe and reliable power supply
- Redundant Communication Bus
- Easy to install and maintain
- Easy system upgrade/downgrade
- Maintenance operation without load interruption.

Software & Connectivity Solutions

Protection Software

GE Data Protection software can communicate with the UPS over RS-232, USB or SNMP to receive status information and measurement values of the UPS. In case of a critical condition (time on battery, remaining battery autonomy time or low battery) for the load, the software starts a controlled shutdown.

An enhanced alarm management system provides the possibility to start applications, send messages, and send e-mails for every upcoming or disappearing alarm.

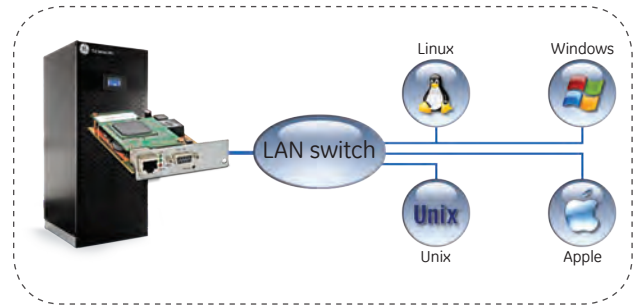

Remote Monitoring and Diagnostic Solution (iUPSGuard)

GE remote monitoring solution is an anytime, anywhere concept in UPS status monitoring and alarm notification supporting all GE UPS product lines.

Accessing the latest site information via Web and being alerted by Email or SMS, it enables the user to make timely decisions in case of changing critical conditions. With comprehensive data collection and analysis it improves diagnostics capability and enhances response time.

- 24/7 remote access to your UPS data using standard web browser
- Automatic alerting in case of event direct and immediately to you cell phone or by email
- Regularly operational reports with proactive information on critical data
- Preventative information using PMAD (Preventative Maintenance & Advanced Diagnostics) feature
- Possibility to reduce intervention and onsite work

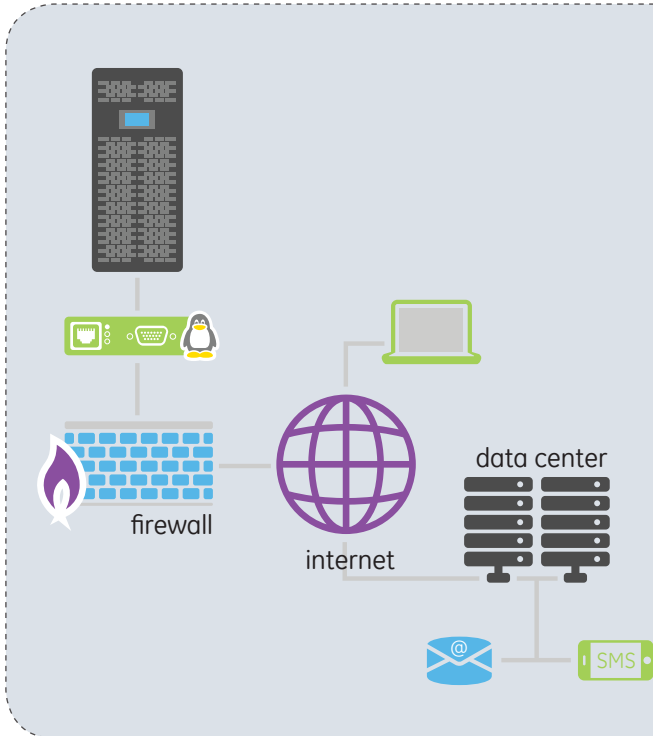

Remote Connectivity to Building Management Systems

This optional Standard Network Management Protocol (SNMP) Plug-In Card allows the UPS to communicate over a LAN or interface through all major building management systems (BMS).

Integrates a modern web server for UPS monitoring Via LAN, drives remote server shutdown in case of critical UPS alarms and works as Modbus TCP Converter "as well as Modbus RTU 485".

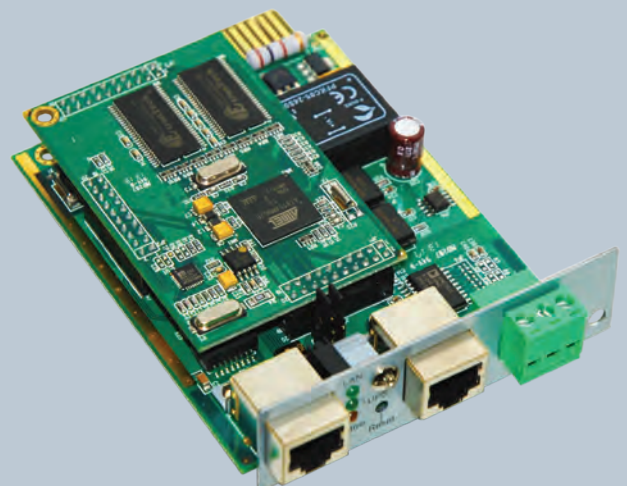

Technical Specifications

Power Rating	Output Power rating (kVA)	160	200	320	400	600	800
	Output Power Rating (kW)	160	200	320	400	600	800
	Output Power Factor	1					
Energy Usage	Efficiency	Up to 96.5%					
	Efficiency (eBoost mode, option)	Up to 99% (Option)					
Technology	Rectifier Technology	IGBT Technology					
	RPA	Up to 6 units					
Physicals	Dimensions (w), mm	820	1420	3020	3420		
	Dimensions (d x h), mm	865 x 1905					
	Weight (kg)	500	950	2400	2800		
Input	Voltage Range	340-460 Vac					
	Frequency Range	45-65 Hz					
	Input power factor	0.99					
	Current THD	< 3%					
Output	Voltage	3 x 380/400/415 Vac, User selectable					
	Frequency	50/60 Hz					
	Voltage THD at Linear load	< 1.5%					
	Voltage THD at Non-linear load	< 5%					
	Voltage Regulation Static	< +/- 1%					
	Topology	VFI (Voltage Frequency Independent) according to IEC 62040-3					
General	Protection Degree	IP 20					
	Ambient operating temperature	0°C up to 40°C					
	Operating modes	Double conversion, automatic bypass, eBoost mode, frequency converter, RPA					
	Standard	CE Mark, IEC 62040-1, IEC 62040-2, IEC 62040-3, IEC 60950					
	Safety Standards	EN/IEC 62040-1					
	EMC Standards	EN/IEC 62040-2					
	Color	RAL 9005, black					

Specifications subject to change without prior notice

UPS Block Diagram

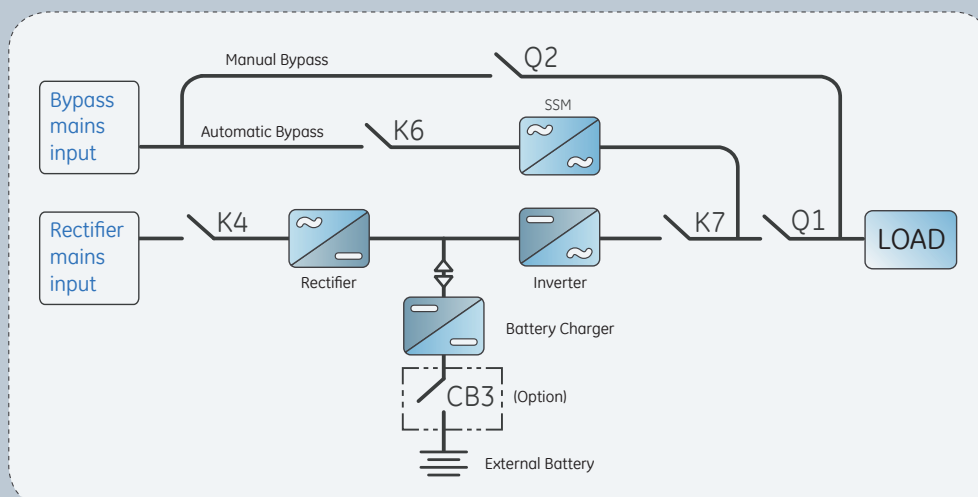

Built-in Standard Feature

- Standard back-feed protection
- Integrated maintenance bypass (for TLE 160-400 kW)

Built-in UPS Options

1. eBoost Operation Mode
2. RPA kit (Redundant Parallel Architecture)
3. Kit for common input mains
4. Auxiliary Power Supply (APS) 24Vdc
5. Surge suppressors



your distributor:

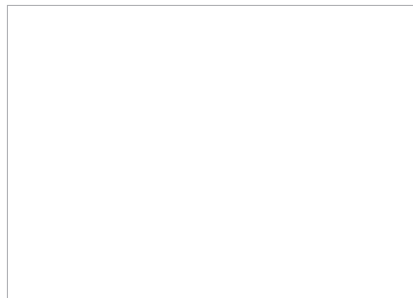

GE Consumer & Industrial SA
Via Cantonale 50
6595 Riazzino (Locarno)
Switzerland
T +41 (0) 91 850 51 51
F +41 (0) 91 850 52 52
E info.ups@ge.com



imagination at work

www.gecriticalpower.com