

GE  
Digital Energy

# SG-CE Series UPS

60 - 600 kVA three phase 400 Vac  
Uninterruptible Power Supply (UPS)



imagination at work

From protecting assets such as generators, transmission lines and motors, to ensuring secure wireless data transmission and **providing uninterruptible power**, GE Digital Energy delivers industry-leading technologies to solve the unique challenges of each customer.



We protect the world's critical equipment to ensure safe and reliable power

## SG-CE Series UPS

### Digital Energy SG-CE Series Uninterruptible Power Supplies 60-600 kVA

The GE Digital Energy SG-CE Series is one of the best performing and most reliable three-phase UPS systems providing critical power protection for a wide range of applications. The SG-CE Series operates in VFI mode (Voltage Frequency Independent) and has been developed to satisfy the growing request of clean input performances through an innovative control algorithm on the IGBT rectifier power components instead of using standard filters. The Digital Energy SG-CE Series is developed using GE's Design for Six Sigma methodology to ensure that the product fully meets customer requirements and expectations.

The SG-CE Series UPS provides top class reliability and performance. With backfeed protection and compliance to EMC and safety standards the SG-CE Series complies to current standards. Reliability can be further increased by paralleling more units utilising GE's unique RPA™ technology (Redundant Parallel Architecture).

Through their complete life cycle, all GE UPS systems are fully supported by service teams which provide world-class, 24x7 preventive and corrective services, training and application expertise.



# Product portfolio

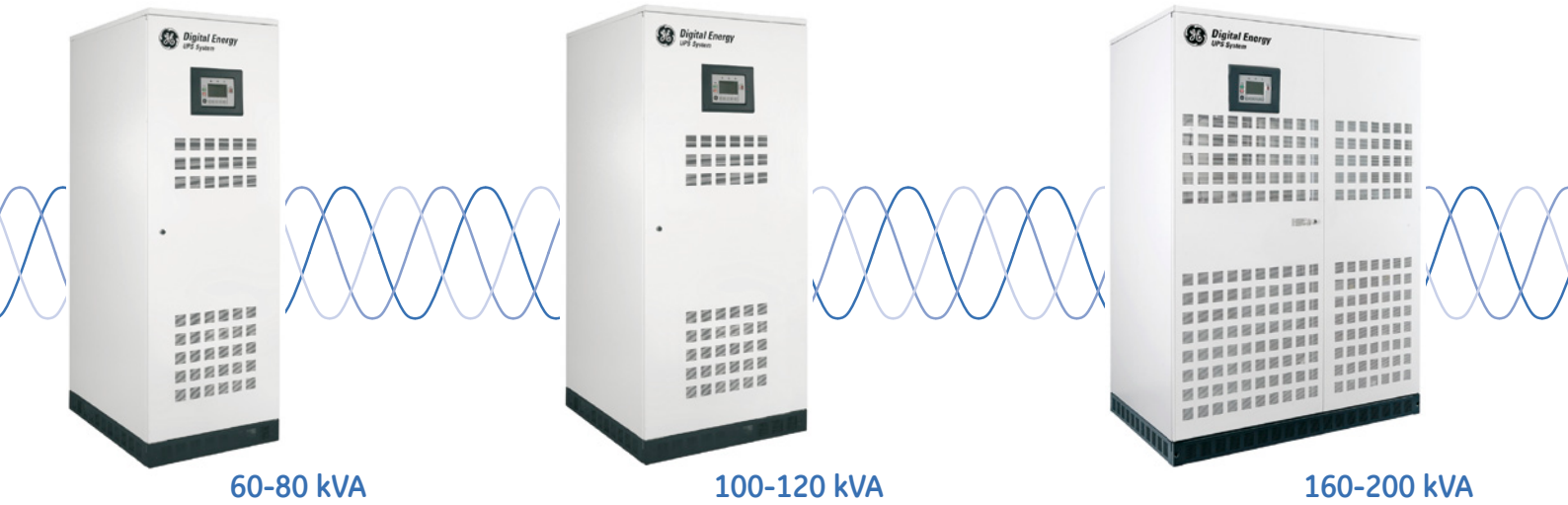

60-80 kVA

100-120 kVA

160-200 kVA

## PurePulse® – IGBT rectifier clean input

Keep your supply network clean. No over sizing required for generators and upfront equipment.

## Output power factor 0.9 leading

Optimized to protect modern IT equipment with unity or capacitive power factor without derating.

## Inverter Zig-Zag isolation transformer

Lowest harmonic distortion and load galvanic separation.

## Space Vector Modulation (SVM)

Improve transient response and reduce Total Harmonic Distortion (THD) with non-linear loads.

## Healthcare

Protects critical equipment from power fluctuations and failures. Protect instruments from potentially harmful uncontrolled shutdowns.

- Diagnostic systems (X-ray, tomography,...)
- Clinical laboratory equipment
- Healthcare IT

## Banking & financial

Financial institutions use advanced power quality systems to ensure that important work on personal accounts and large transactions is not lost due to system interruptions.

- Stock exchange
- Financial transactions
- Data centers

## Data centers, server farms

A data center that can't guarantee its customers' continuous access to data, won't be in business for long. We deliver Power Quality solutions to keep them running.

- Servers (LAN, WAN, ...)
- Web providers
- Data centers





250-300 kVA



400-500-600\* kVA

(\* SG-CE Series 600 kVA only with thyristor rectifier technology)

PurePulse®

**Extremely low output voltage distortion**

Results in a very clean output waveform for any load.

**True front access**

Front access for operation and maintenance. Reduces operational footprint, maintenance and repair cost.

**Superior Battery Management (SBM)**

Enhances battery life and reduces operational cost.

**True high efficiency at full and partial load**

Improved efficiency in real working conditions. Saving direct and indirect energy costs.

**Industrial systems**

Industrial automation equipment and control systems rely on our UPS systems for uninterruptible power to keep the process running.

- Process control
- Robotics
- PLC and digital drivers

**Transportation systems**

Provide reliable energy to infrastructure, roads, railways, airways, to guarantee safe transportation of people and goods.

- Air traffic control
- Railway signaling
- Tunnel lighting

**Critical infrastructure**

Ensuring continuous and reliable power supply for critical applications, essential for public and private services.

- Emergency lighting
- Security systems
- Fire alarm systems
- Building automation
- Point Of Sales (POS)

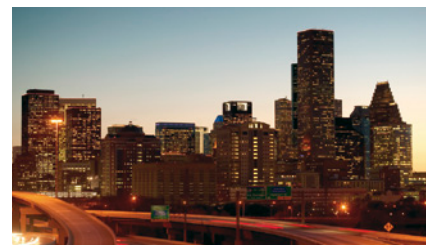

## PurePulse® - IGBT rectifier clean input

PurePulse is an innovative control algorithm applied on the IGBT rectifier (available from 60 to 500 kVA).

This current source rectifier assures an input Total Harmonic Distortion (THDi) of less than 2% and draws a pure sinusoidal waveform from the mains.

### PurePulse advantages

- UPS input performances
  - Total Current Harmonic Distortion THDi = 2% without additional harmonics filters
  - UPS input power factor: 0.99
- Constant behavior at all loads
  - Negligible harmonics contents at full and partial loads.

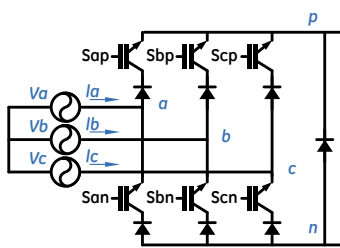

## Digital Signal Processor (DSP)

- High speed sampling rate for precise control allows for reliable distributed control
- Faster response time
- Redundant high speed communication
- All digital controls for increased reliability and stability
- All system control parameters are adjustable from the front panel
- Redundant microprocessors located on the main control board
- Graphical display panel provides easy-to-read menus and simple navigation.

## Zig-Zag output isolation transformer

The Zig-Zag transformer enables the UPS to run with heavily unbalanced loads while supplying full kVA output capacity at 100% non-linear load.

The secondary windings of the output transformer form a Zig Zag pattern from neutral cancelling triplen (3<sup>rd</sup> order) load harmonics. This reduces neutral conductor loading and losses in all the conductors and the input transformer.



## Superior Battery Management (SBM)

The battery system of a UPS must be periodically maintained and monitored to ensure it is fully operational when needed.

Every GE UPS incorporates a standard feature called Superior Battery Management (SBM) that can be configured to periodically test the battery system and calculate true battery runtime using measured values for temperature and load.

### SBM advantages

- Works with all battery types
  - Software compensates for battery types such as flooded, VRLA and NiCad
- Online battery test
  - The risk of utility power loss to the load during battery tests is prevented by an energized rectifier
- Increases battery life
  - Heavy-duty rectifier/charger delivers "managed charge" current to the battery system.

## Space Vector Modulation (SVM)

Space Vector Modulation is the next generation of Pulse Width Modulation (PWM) inverter control technology. SVM uses an advanced switching technique for PWM driving Insulated Gate Bipolar Transistors (IGBT). The objective of SVM is to generate the output voltage vector using simpler switching pattern combinations.

In traditional PWM, the triangle wave is compared to a reference sine wave. The result is a pulse width modulated rectangular waveform, which is used to provide gate signals to the IGBTs.

PWM signals have to be calculated in real time and normally require 3-dimensional calculations (one for each three phase leg) to determine the inverter state. By using SVM, the calculation is simplified to a 2-dimensional "space vector" in a polar coordinate plane, speeding up the response and improving system performance.

### SVM advantages

- Higher efficiency at full and partial load
  - Reduces IGBT switching losses
- Improved output performance
  - Reduces Total Harmonic Distortion (THD) with non-linear loads and improves transient response to step loads
- Precise paralleled system performance
  - More accurate load sharing for RPA operation.

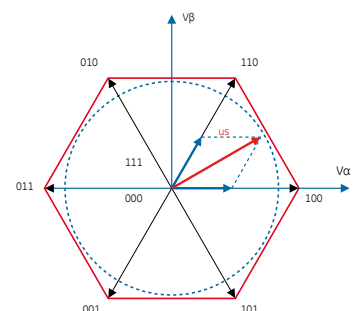

# Input performance

## Robust rectifier for wide input range

The wide AC input voltage and frequency window avoids unnecessary battery discharge even when operating from an unstable AC source (i.e. diesel generator).

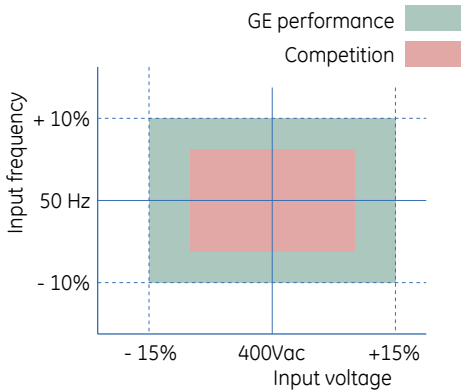

## Programmable soft start feature

SG-CE Series rectifier allows a flexible power walk-in, programmable time period (0-30 seconds) eliminating in-rush current. This feature avoids the need of oversizing the input power system as for motor generators, overcurrent devices and protection devices.

## Generator compatibility

User-programmable features such as slew rate, phase angle rate-of-change and voltage rate-of-change allow the UPS to quickly synchronize to a genset during emergency back-up.

## PurePulse® technology for clean input source

From thyristor to IGBT rectifier, a technology breakthrough innovation toward the future.

PurePulse is an innovative control algorithm applied on the IGBT rectifier. This current source rectifier assures an input Total Harmonic Distortion (THDi) of less than 2% with input power factor PF = 0.99 and draws a pure sinusoidal waveform from the mains. The advantages of GE's PurePulse technology span from savings in the sizing of upfront equipment (such as emergency generator, cabling and circuit breakers) to a total elimination of cost for additional active or passive filters.

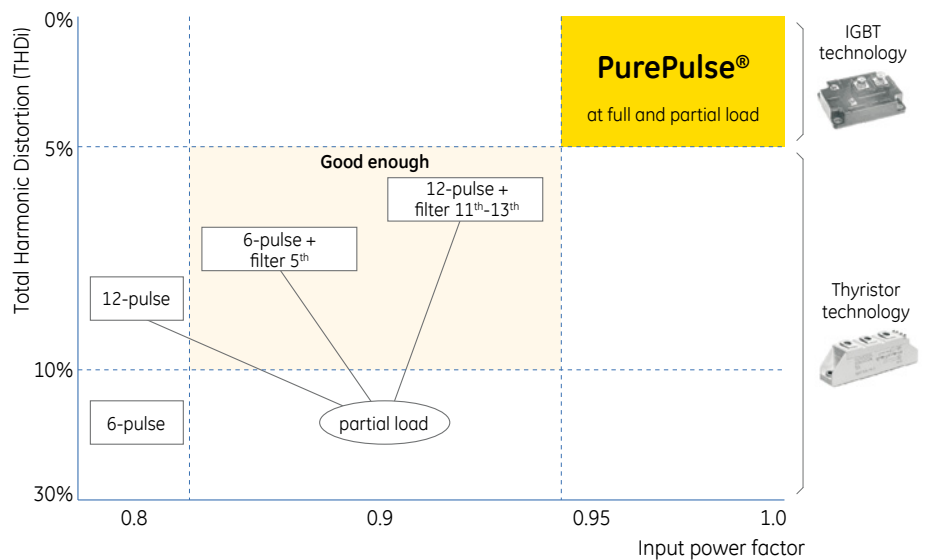
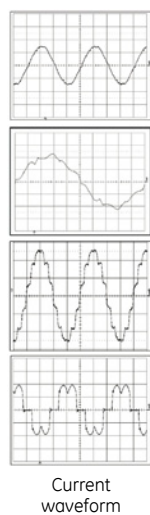

## PurePulse technology benefits

- Saving in the sizing of upfront equipment e.g. emergency generators, cabling, circuit breakers, .....
- Saving cost due to no additional filters  
Avoid the installation and the tuning of additional harmonics traps
- No disturbances to nearby equipment  
Eliminate any cause of perturbation and outage on upfront electrical equipment, avoiding also any investigation and analysis cost due to malfunction.

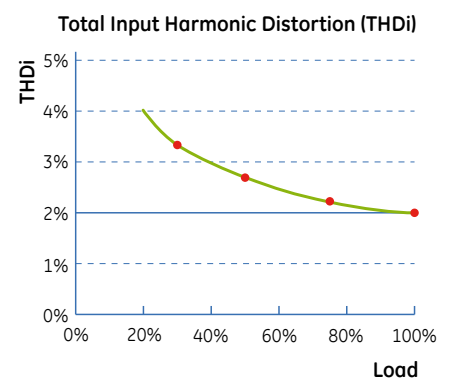

# Output performance

## Total Harmonic Distortion (THD)

A distorted output voltage waveform affects the proper functioning of the load's equipment. The SG Series has very low output voltage THD, even with connected 100% unbalanced or 100% non-linear loads.

## Transient response

With the use of SVM and the Zig-Zag transformer, the GE UPS can react very quickly to zero-100% step loads (within 1/3 cycle). This reduces the need to oversize the UPS for severe pulse-load applications.

## Voltage regulation

SVM and the Zig-Zag transformer enable the inverter to react very quickly under step load conditions. As a result, the GE UPS has very tight voltage regulation during step loads and 100% phase-to-neutral (Ph-N) load imbalances.

## Overload capability

The SG-CE Series UPS has a robust inverter capable of delivering 150% overload for 1 minute and 125% for 10 minutes, ensuring power protection safety for applications requiring start-up overcurrent and for temporary peak load.

## Short-circuit capability

The SG-CE Series inverter supplies 2.7 and 4.0 times (for 200 ms) the nominal current respectively for ph-ph and ph-N/PE short-circuit, ensuring the proper selectivity of the protection devices (fuses and breakers).

## Output power capability \*

Nowadays IT installation requirements is driving to power sources able to supply loads with leading power (capacitive loads) without affecting the power capability. Whereas most of the UPS available in the market are designed to supply loads up to power factor 0.8 lagging, the SG-CE Series UPS are able to supply full power without any derating for all loads from 0.9 lagging to 0.9 leading. This unique characteristic avoids any UPS oversizing in case of unity or leading power factor as for computer loads. The table below shows the additional power (kW) available compared to UPS designed according to traditional technology.

UPS rating	500 kVA			
Load power factor	0.8 lagging	0.9 lagging	1	0.9 leading
GE-SG-CE Series	400 kW	450 kW	450 kW	450 kW
Traditional technology for PF=0.8	400 kW	387 kW	362 kW	300 kW
SG-CE Series additional power available	0%	+16%	+24%	+50%

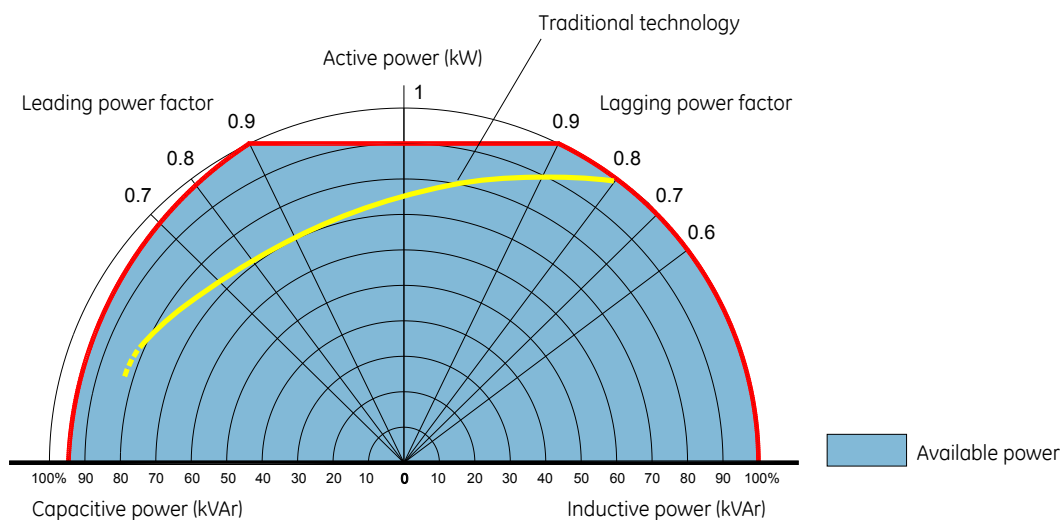

SG-CE Series power capability (60-500 kVA)

\* Not applicable for SG-CE Series 600 kVA



# Efficiency

## UPS efficiency

The GE SG Series is one of the most energy efficient double conversion UPS in the industry and provides world-class energy efficiency across the operating load range. Most UPS systems operate at part load, not at full load, therefore GE's UPS performance is optimized at part load operation.

The optimization of the SG Series includes selecting all components (rectifiers, transformers, etc.) based on maximizing the component efficiency at part load conditions, not full load.

## True efficiency

GE UPS efficiency data are real values confirmed by measurements, representing the state of the art of power electronic technology.

This avoids any surprise in cooling system design and in economical evaluation of energy consumption over the life cycle, ensuring peace of mind for your investment.

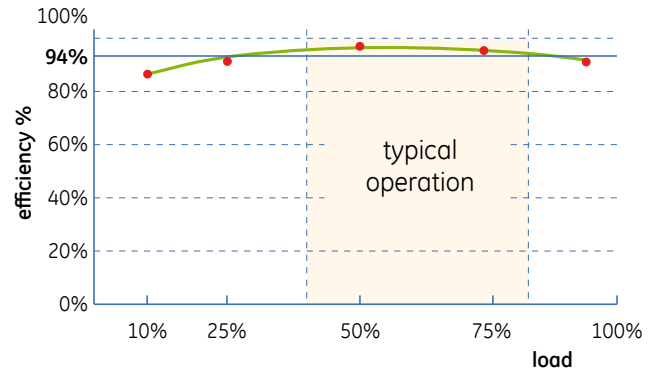

## Super Eco Mode™

**During normal operation** the UPS runs in double conversion mode (VFI mode – Voltage & Frequency Independent).

Both the rectifier and the inverter are continuously operating to ensure a clean and reliable power supply. In the two conversion processes (rectifier + inverter) and the transformer energy losses occur.

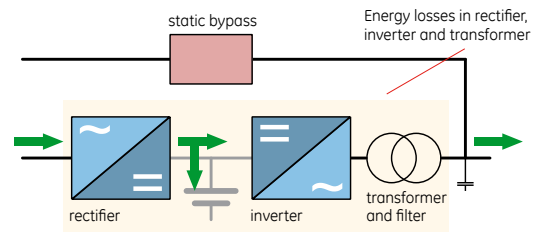

**During Super ECO Mode operation** the load is supplied directly by the mains, via the bypass circuit. This provides an efficiency up to 98.5%. In case the mains is out of tolerance, the UPS will immediately transfer the load to inverter again, to ensure a stable and reliable power supply. The battery is maintained charged by the rectifier to provide back-up in case of a mains failure.

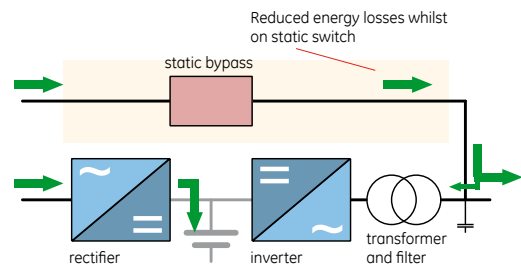

### Super Eco Mode advantages

- High efficiency up to 98.5%
- Reduced heat generation
- Energy savings on cooling system
- Extremely fast transfer time to inverter <2ms in case of mains failure

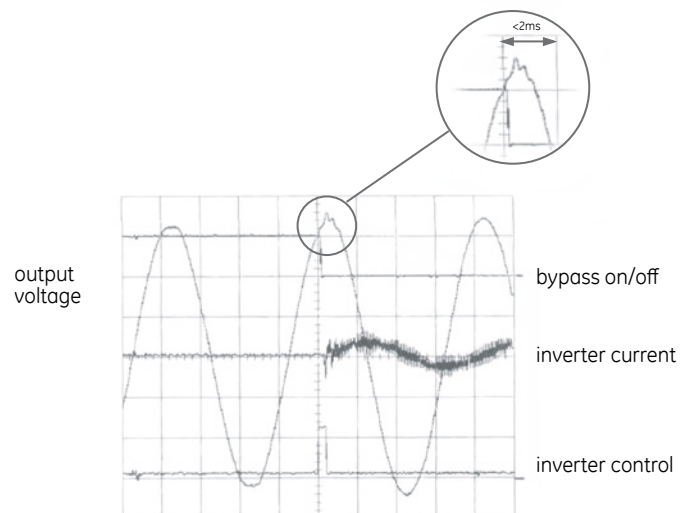

# RPA™ - Redundant Parallel Architecture™

GE provides a unique technology called Redundant Parallel Architecture (RPA) that can parallel Uninterruptible Power Supply (UPS) modules with true redundancy. With RPA, there is no need for external electronics or switches to control the UPS modules in the parallel system. One of the UPS modules in the system arbitrarily takes a leadership role, while the other UPS modules have access to all control parameters. If one UPS fails to operate, the load is automatically redistributed among the others. If the lead UPS fails to operate then a different UPS automatically takes on the leadership role.

The RPA systems are designed to have no single points of failure, ensuring the highest level of power protection for critical loads.

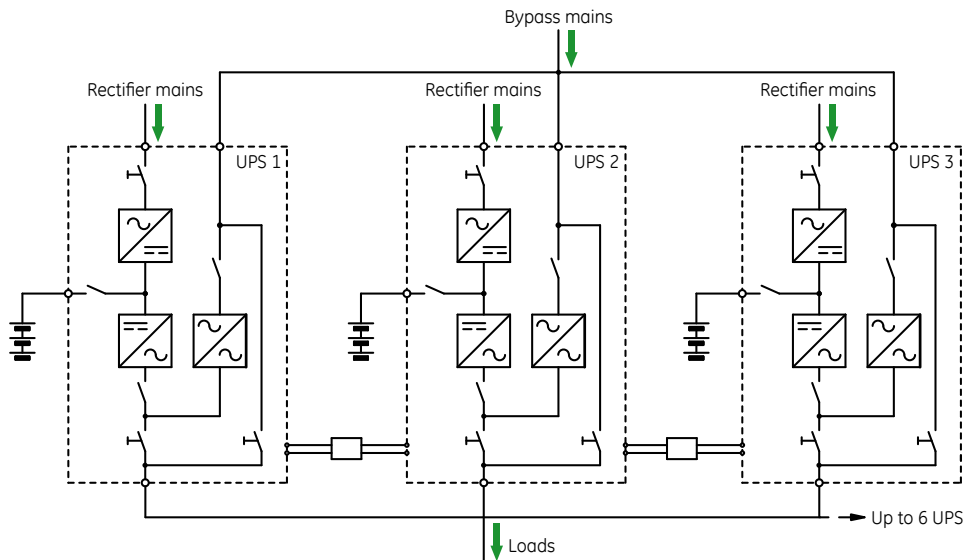

*Standard RPA configuration  
True redundancy with distributed control & bypass*

## RPA advantages

### No single points of failure

The RPA system provides complete redundancy of all critical components, allows paralleling of up to six (6) units for increased load capacity or redundancy, and ensures excellent dynamic behaviour based on shared output voltage regulation.

### Scalable and modular

The system can be easily expanded for higher capacity and redundancy without any interruption to the critical load or transfer to bypass.

### Redundant communication

Redundant high speed bus and control electronics provide higher system reliability.

### Distributed control logic

Each module in an RPA system has its own operational controller. Each one continuously communicates with all others in order to manage the entire system like a team.

### Online maintenance

N+1 configurations allow maintenance on any single module in the system while other modules provide online protection with battery backup.

### Sequential soft start

Provides sequential soft start of each module to reduce instantaneous load on input feeders during mains recovery. This helps avoid over-rating of generator and over heating of cables and fuses.

### Load sharing and phase synchronization

With each module utilizing SVM, inverter switching, load sharing and phase synchronization between modules in RPA is one of the tightest in the industry (0.03 ms.), providing better control of output voltage.

### Smaller footprint

RPA eliminates centralized control and external static bypass cabinet.

# Connectivity solutions

## Power Diagnostics

GE Power Diagnostics is an anytime, anywhere concept in UPS status monitoring and alarm notification that has been successfully implemented in numerous of installations supporting up to multi-hundred UPS.

Based on the leading Intelligent Remote Information System IRIS all GE UPS types as well as 3<sup>rd</sup> party UPS are supported. Accessing the latest site information via Web and being alerted by Email, SMS or Fax, it enables the user to make timely decisions in case of changing critical conditions.

With comprehensive data collection and analysis IRIS is not only a remote monitoring & diagnostics (RM&D) system, but the core of the integrated service offering GE Power Diagnostics.

## Customer benefits

- 24\*7 remote access to your UPS data using standard web browser
- Automatic alerting in case of event direct and immediately to you cell phone or by email
- Regularly operational reports with proactive information based on data validation from our diagnostics team, analysing
  - Critical trends and probability of future problems
  - Required actions for maintenance or components replacement
- Preventative information using PMAD (Preventative Maintenance & Advanced Diagnostics) feature
- Possibility to reduce intervention and onsite work
  - Remote troubleshooting and online guidance for fault finding
  - Potential to minimize repair times as a result of data analysis. Service team is arriving pre-informed and prepared to solve the problem and is carrying the right spare parts.

## Topologies

IRIS offers various communication possibilities which can be easily combined to match your requirements:

- Analog modem using normal phone line
- GPRS modem using cell phone network
- Network solution using SNMP communication over Ethernet.



Technology operation center Beijing

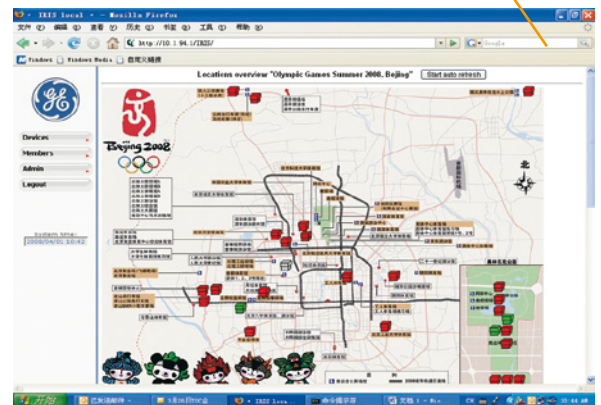

Graphical status overview

# Technical specifications

Topology	VFI (Voltage Frequency Independent) according to IEC 62040-3
Operating Modes	Double conversion, automatic bypass, super ECO mode, frequency converter, RPA
Standard	CE Mark, IEC 62040-1, IEC 62040-2, IEC 62040-3, IEC 60950

Output power rating (kVA)	60	80	100	120	160*	200*	250*	300*	400	500	600
Output power rating (kW)	54	72	90	108	144	180	225	270	360	450	540
Output power factor	0.9 leading										
Rectifier technology	IGBT PurePulse®				IGBT PurePulse® / Thyristor				IGBT PurePulse®	Thyristor	
Dimensions (w x d x h), mm	650x850x1900		835x850x1900		1350x850x1900		1500x850x1900		1800x950x1900		1950x950x1900
Weight (kg) (SG-CE Series / SG-CE Series PurePulse)	550	630	860		1100/1225	1150/1315	1400/1675	1450/1775	2400	2600	2950
Audible noise, db(A)	< 65				< 69				72		< 75
Efficiency (super ECO mode)	up to 98.5%										
Efficiency	up to 94%										
RPA	up to 6 units										
Protection degree	IP 20										
Input voltage range	340 - 460 Vac										
Input frequency range	45 - 65 Hz										
Input current THD	< 2% **										6%
Output voltage	3x380/400/415Vac, user selectable										
Output frequency	50/60 Hz +/- 0.01%										
Output voltage THD at linear load	< 1.5%										
Output voltage THD at non-linear load	< 3%										
Output voltage regulation static	< +/- 1%										
Output voltage regulation dynamic (100% step load)	< +/- 2% (recovery time < 5 ms)										
Overload capability on inverter	125% 10 min., 150% 1 min.										
Ambient operating temperature	0 - 40 °C										
Colour	RAL 9003, white										
Safety standards	EN/IEC 62040-1										
EMC standards	EN/IEC 62040-2										

\* Available with either thyristor or PurePulse IGBT rectifier

\*\* PurePulse IGBT rectifier

Specifications subject to change without prior notice



your distributor:

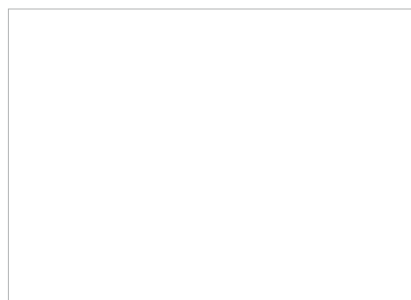

GE Consumer & Industrial SA  
Via Cantonale 50  
6595 Riazzino (Locarno)  
Switzerland  
T +41 (0) 91 850 51 51  
F +41 (0) 91 850 52 52  
E gedeinfo@ge.com

Visit us online at:  
[www.gepowerquality.com](http://www.gepowerquality.com)

